

KENWOOD

ProTalk DIGITAL

NX-P500

UHF DIGITAL TRANSCEIVER

USER MANUAL



JVCKENWOOD Corporation

B5A-2558-00/00 (K)

CONTENTS

PREPARATION	5
INSTALLING/ REMOVING THE BATTERY PACK.....	5
INSTALLING THE BATTERY PACK.....	5
REMOVING THE BATTERY PACK.....	5
CHARGING THE BATTERY PACK.....	6
INSTALLING / REMOVING THE BELT CLIP HOLSTER.....	8
INSTALLING THE OPTIONAL SPEAKER/ MICROPHONE (OR HEADSET).....	9
ORIENTATION	10
BUTTONS AND CONTROLS.....	10
DISPLAY.....	11
BASIC OPERATION	13
SWITCHING POWER ON.....	13
ADJUST THE VOLUME.....	13
SELECT A CHANNEL.....	13
MAKE A CALL.....	14
RECEIVE VOICE.....	14
CONTINUE CALLING.....	14
SWITCHING POWER OFF.....	14
CHANNEL SETUP MODE	15
CHANNEL TYPE.....	16
TRANSMIT MODE.....	16
TRANSMIT POWER.....	17
PRIVACY TALK.....	17
PTT ID (Analog FleetSync)/ SELCALL ON PTT (Digital NXDN).....	19
COMPANDER.....	19
MONITOR.....	20
SQUELCH OFF.....	21
SIGNALING	22
QUIET TALK/ DIGITAL QUIET TALK (Analog).....	22
RAN (RADIO ACCESS NUMBER).....	24
FleetSync: ALPHANUMERIC 2-WAY PAGING FUNCTION	25
SELCALL MODE (SELECTIVE CALLING).....	25
NXDN	29
SELCALL MODE (SELECTIVE CALLING).....	29
VOICE OPERATED TRANSMISSION (VOX)	33
VOX OPERATION.....	33

SCAN..... 34

- SCAN BUTTON SETUP 34
- SCAN OPERATION 34
- REVERT CHANNEL 35

LOCK FUNCTION 36

- BUTTON LOCK 36
- SUPER LOCK..... 36

SETTING MODE..... 37

- CHANNEL FREQUENCY SETUP 39
- PROFILE NUMBER 40
- INDIVIDUAL CALL ALERT TONE..... 40
- GROUP CALL ALERT TONE..... 41
- INDIVIDUAL CALL ALERT LED COLOR..... 41
- GROUP CALL ALERT LED COLOR 42
- INCOMING CALL NOTIFICATION..... 43
- BUTTON ASSIGNMENT 44
- CALLING ALERT TONE 46
- HOME CHANNEL 46
- SECOND CHANNEL 47
- SECOND CHANNEL OPERATION:..... 48
- TRANSMIT TONE LEVEL 49
- PTT ID SIDETONE 49
- CALLER ID DISPLAY 50
- PTT HOLD 50
- MODE RESET TIMER 51
- TIME-OUT TIMER 51
- BUSY CHANNEL LOCKOUT..... 52
- INCORRECT SIGNALING NOTIFICATION 52
- DISPLAY BACKLIGHT 53
- BATTERY SAVER..... 54
- BEEP TONE..... 55
- SQUELCH LEVEL 55
- MICROPHONE SENSE 56
- EXTERNAL MICROPHONE SENSE 56
- MICROPHONE TYPE 57
- AUDIO EQUALIZER (RX AUDIO RESPONSE)..... 58
- AUDIO EQUALIZER (TX AUDIO RESPONSE) 58
- ENCRYPTION KEY DATA..... 59

VOX SETUP.....59

VOX GAIN LEVEL.....59

VOX DELAY TIME.....60

TRANSMIT INHIBIT WHILE RECEIVING.....60

VOX PROCEED TONE61

EARPHONE MODE.....62

SELECTABLE POWER ON LED63

SELECTABLE POWER ON TONE.....64

BACKGROUND OPERATIONS..... 65

 BATTERY LEVEL INDICATOR65

RESETTING THE TRANSCEIVER 65

OPTIONS 66

TROUBLESHOOTING GUIDE 67

SPECIFICATIONS 67

PREPARATION

Shows how to use supplied accessories of this transceiver.

For options not supplied, sold separately, refer to the list {p.66}.

INSTALLING/ REMOVING THE BATTERY PACK

The battery pack is not charged at the factory; charge it before use.



CAUTION

- ◆ Do not short the battery terminals or dispose of the battery by fire.
- ◆ Never attempt to remove the casing from the battery pack.

INSTALLING THE BATTERY PACK

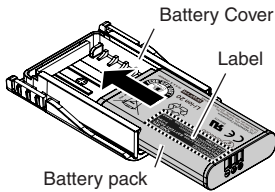

1 Insert the battery pack into the battery cover.

- Pay attention to the position of notch of the battery pack.
- Insert the battery pack with the model name label facing up.
- Be careful not to drop the battery pack.

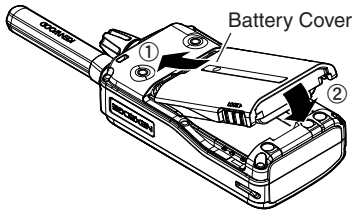

2 Align the battery cover with the groove on the back of the transceiver.

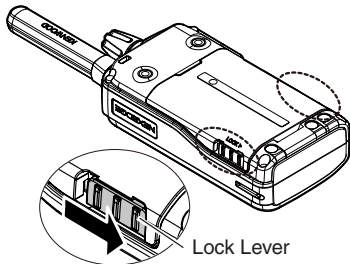

3 Slide the Lock lever (both side) to lock it.

- There will be feedback in the form of a click.

REMOVING THE BATTERY PACK

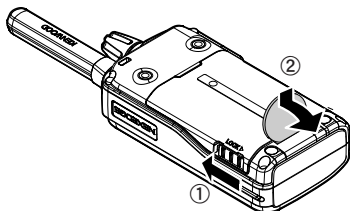

1 Slide the lock lever (both side) to unlock.

2 Release the lock on the battery cover, then remove the battery cover with a coin or the like.

- Be careful not to drop the battery pack.

CHARGING THE BATTERY PACK

The battery pack is not charged at the factory; charge it before use.

Average battery pack life:

Transmit Power HIGH	Transmit Power LOW
Battery Saver on: 15.5 hours	Battery Saver on: 16.5 hours
Battery Saver off: 14 hours	Battery Saver off: 15 hours

- Average times are calculated using 5% transmit time, 5% receive time, and 90% standby time.

1 Plug the AC adapter cable into the jack located on the bottom of the charger.

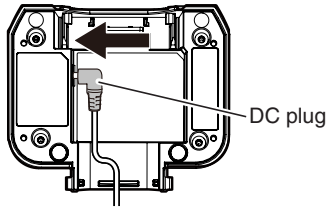

2 Plug the AC adapter into an AC outlet.

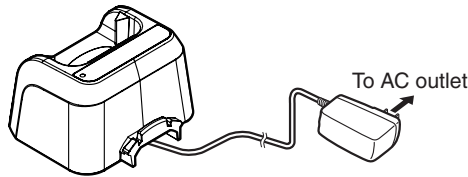

3 Slide a transceiver equipped with a battery pack into the charging slot of the charger.

- Make sure the metal contacts of the battery pack mate securely with the charger metal terminals.
- The indicator lights red and charging begins.

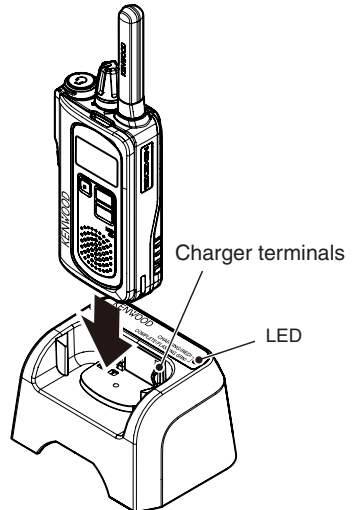

**CAUTION**

- ◆ Always switch OFF a transceiver equipped with a battery pack before inserting the transceiver into the charger.
- ◆ Always remove the AC adapter from an AC outlet before attempting to inspect or clean the charger. Removing the battery packs or changing the controls does not remove the AC voltage from the charger.
- ◆ Position the AC adapter cable so it will not be stepped on, tripped over, nor subjected to damage.
- ◆ Always remove the AC adapter from an AC outlet by pulling on the adapter rather than the cable.
- ◆ Do not use the charger if it has a damaged AC adapter or adapter cable, or if the charger has been damaged in any way. Contact your **KENWOOD** dealer to replace or repair the damaged part.

- 4** When charging is completed, the indicator flashing green. Remove the battery pack or the transceiver from the charging slot of the charger.
- It takes approximately 4.5 hours to charge the battery pack.
 - When the charger will not be used for a long time, unplug the AC adapter from the AC outlet.

Note:

- ◆ The ambient temperature should be between 41°F and 104°F (5°C and 40°C) while charging is in progress. Charging outside this range may not fully charge the battery.
- ◆ The battery pack life is over when its operating time decreases even though it is fully and correctly charged. Replace the battery pack.

LED Status

Indicator color	Meaning
Light Red	A transceiver is in the charging slot and charging has started.
Flashing Red	the battery pack is either defective or the battery pack contacts are not properly mated with those of the charger.
Flashing Green	Charging is completed; remove the battery pack from the charger.
Alternates flashing green and orange	The temperature of the battery pack has not satisfied the charging start temperature. Remove the battery pack from the charger and wait until it reaches a normal temperature before charging it again.

INSTALLING / REMOVING THE BELT CLIP HOLSTER

- 1 Installing the transceiver on the belt clip holster.
 - Insert the transceiver until sound is heard "click".
- 2 Push the upper part of the holster to the rear side, remove the lock and pull out the transceiver.

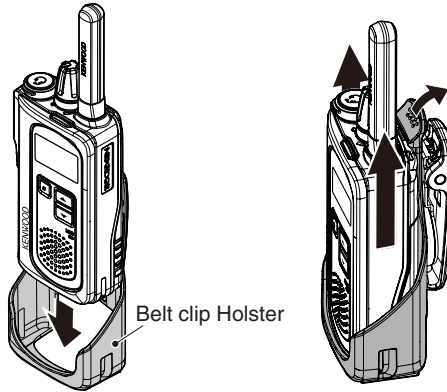

Note:

- ◆ When pulling the transceiver out of the holster, do not hold the antenna, please pull out with holding both sides.
-

INSTALLING THE OPTIONAL SPEAKER/ MICROPHONE (OR HEADSET)

- 1 Turn the transceiver power OFF.
 - For transceivers that are able to adjust the volume level, adjust the volume to the minimum setting before turning the transceiver power OFF.
- 2 Insert the plug into the SP/MIC jack on the transceiver, then fix it with a nut.
 - Fix the plug with a nut firmly to maintain waterproof protection for the transceiver.

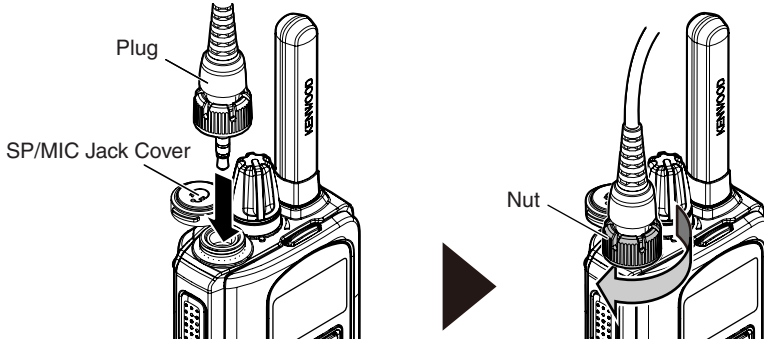

Note:

- ◆ When using an optional speaker/ microphone, clip mic. with earphone, or headset, to keep the transceiver dust and water protection, insert the plug to the transceiver's SP/ MIC jack and tighten the option's nut securely with no gap.
 - ◆ When not using an optional speaker/ microphone, clip mic. with earphone, or headset, to keep the transceiver dust and water protection, you must cover the SP/MIC jack with the cap securely with no gap.
-

ORIENTATION

BUTTONS AND CONTROLS

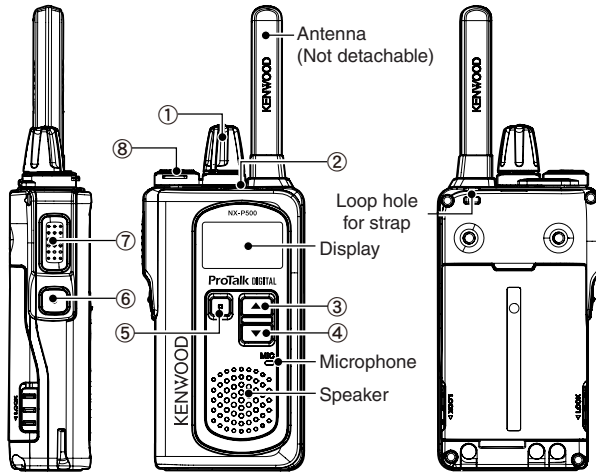

① Power switch/ Volume control

Turn clockwise to switch ON the transceiver. To switch OFF the transceiver, turn counterclockwise until a click sounds. Rotate to adjust the volume level.

② LED indicator

For the LED indicator status, refer to {p.14}.

③ ▲ (Up) button

Press to change the operating channel, to select a menu in Setting mode, and to perform other functions.

④ ▼ (Down) button

Press to change the operating channel, to select a menu in Setting mode, and to perform other functions.

⑤ Menu button

Press to perform various functions. Press and hold while switching the power ON to enter Setting mode.

⑥ Side button

Press before making a call to alert the other party members, or press to select a unit ID to make a call.

⑦ PTT (Push to Talk) switch

Press and hold, then speak into the microphone to transmit.

⑧ SP/ MIC jack

Insert the speaker/ microphone or headset plug into this jack.

DISPLAY

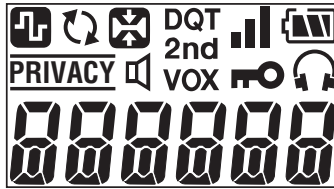

Indicator	Description
	When receiving : Displays the signal strength. When transmitting : Displays the transmit power. Receiving : : Strong : Sufficient : Weak Transmitting : : High Power (2.0 W) : Low Power (1.0 W)
	Displays the battery power. :High :Sufficient :Low (Flashing) :Very Low
	Appears when channel type is set to Digital or mixed mode and transmit mode is set to Digital.
DQT	Appears when the channel is set up with a DQTcode.
	Appears when the Scan is in progress. Blinks when the scan is paused.
	Appears when the Compander is activated.
PRIVACY	Appears when the Encryption (Digital) or Scrambler (Analog) function is activated.
VOX	Appears when the VOX is in progress.
	Appears when the Button lock function is activated.
	Appears when the Earphone mode is activated.
2nd	Appears when the Second Scan function is activated. Blinks when pausing Second Scan and staying on Second Channel.
	Appears when the Monitor open or Squelch off is activated.

Font Pattern

Because the display is segmented, alphabets and numbers are displayed as shown below.

"X" and "Z" are not used in this transceiver.

A	B	C	D	E	F	G	H	I	J
A	b	c	d	E	F	G	H	I	J
K	L	M	N	O	P	Q	R	S	T
K	L	m	n	o	P	q	R	S	t
U	V	W	Y	-	>				
U	v	w	Y	-	>				
0	1	2	3	4	5	6	7	8	9
0	1	2	3	4	5	6	7	8	9

BASIC OPERATION

SWITCHING POWER ON

Switch the transceiver power ON by turning the **Power** switch/ **Volume** control clockwise.

- A confirmation tone sounds, the LCD lights up momentarily, then the current channel number is displayed.

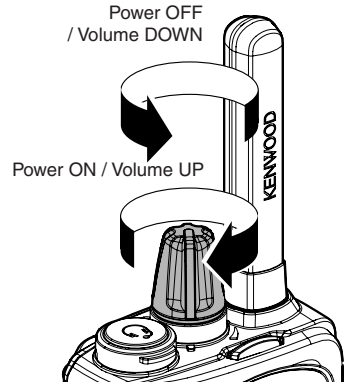
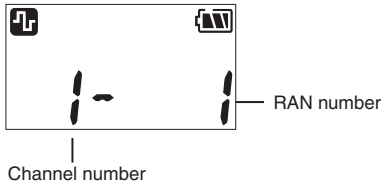

- Setting the color of the LED that lights up when the power is on, groups can be color coded when grouping is necessary. Once you have decided on the color of group, you can discovered which group immediately after turning on the power. {p.63}

ADJUST THE VOLUME

Set your desired volume level by rotating the Power switch/ Volume control.

- Clockwise increases the volume and counterclockwise decreases the volume.

Note:

- ◆ To adjust the volume using background noise as a reference in Analog mode, use the Squelch off Function.

SELECT A CHANNEL

Select a channel by pressing the ▲ or ▼ button.

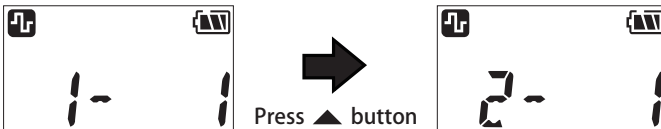

- A confirmation tone sounds each time you press the ▲ or ▼ button.

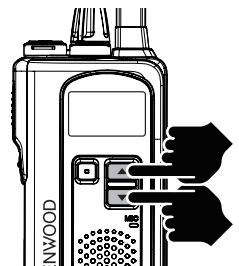

MAKE A CALL

To make a call, press and hold the **PTT** switch, then speak around the microphone area using your normal speaking voice.

- Hold the microphone approximately 1.5 inches (3 to 4 cm) from your lips.



RECEIVE VOICE

Release the PTT switch to receive.

A signal strength icon is appears on the display and the LED lights in green.

When the other party sends it, you hear the voice of the other party.

CONTINUE CALLING

It alternately transmits and receives.

After the other party 's call is over, press **PTT** switch and send.

SWITCHING POWER OFF

After use, turn off the power. To switch the transceiver power OFF, turn the Power switch/ Volume control fully counterclockwise, until a click sounds.

LED INDICATOR STATUS

Indicator Color	Meaning
Lights red	Transmitting
Lights green	Receiving a call. Squelch Off function is activated.
Blinks red	When the battery power low warning is activated.

CHANNEL SETUP MODE

This mode changes the setting of Analog and Digital functions that can be set for each channel.

1 Press the **Menu** button .

- Displays the setting items of Channel setup mode.



2 Press the ▲ or ▼ button to select your desired setting items.



3 Press the **Menu** button then press the ▲ or ▼ button to select your desired value for the setting items.



4 Press the **Menu** button to exit the selection.

5 Press the **PTT** switch or the **Side** button to exit Channel setup mode.

Setting item LIST

Display	Name	Analog	Digital	Settings	Default	Ref. Pg
tYPE	Channel Type	✓	✓	Analog/ Digital/ Mixed	Digital	16
t-modE	Transmit mode	✓	✓	Analog/ Digital	Digital	16
QtDQt	QT/ DQT (Analog)*1	✓		OFF/ QT01 ~ 45/ DQT001 ~ 174	QT01	22
PRn	RAN (Digital)*2		✓	OFF/ 1 ~ 63	1	24
t-PwP	Transmit Power	✓	✓	Low/ High	High	17
SCR	Scrambler (Analog)*1	✓		OFF/ ON	OFF	17
ENCryp	Encryption (Digital)*2		✓	OFF/ ON	OFF	18
Ptt ID	PTT ID (Analog)*1	✓		OFF/ BOT/ List 1~ 99	OFF	19
Ptt ID	Selcall on PTT (Digital)*2		✓	OFF/ List 1~ 99/ Reserved Group	Reserved Group	19
Compd	Compander (Analog)*1	✓		OFF/ ON	OFF	19
VOX	VOX	✓	✓	OFF/ ON	OFF	33

*1: It can be set when Channel type is Analog or Mixed and Transmit mode is Analog.

*2: It can be set when Channel type is Digital or Mixed and Transmit mode is Digital.

CHANNEL TYPE

It is possible to set the channel to Analog operation or Digital operation, or Mixed mode which can wait for both Analog and Digital reception.

- 1 Enter the Channel setup mode {p.15}.
- 2 Press the ▲ or ▼ button to select “TYPE”.



- 3 Press the **Menu** button then press the ▲ or ▼ button to select your desired value.

ANLG	Analog	It operates in Analog.
DGTL	Digital	It operates in Digital.
MIX	Mixed	It can receive both Analog and Digital simultaneously. You can share the channel you used in Analog and Digital.

- Transmission on the channel set to Mixed is transmitted in Analog or Digital set in Transmit Mode.
- 4 Press the **Menu** button to confirm the selection, then press the **PTT** switch or the **Side** button to return to the operation mode.

TRANSMIT MODE

When Channel type is Mixed, set whether to transmit by Analog or Digital.

- 1 Enter the Channel setup mode {p.15}.
- 2 Press the ▲ or ▼ button to select “t-mode”.



- 3 Press the **Menu** button then press the ▲ or ▼ button to select your desired value.

ANLG	Analog	Transmitting in Analog.
DGTL	Digital	Transmitting in Digital.

- 4 Press the **Menu** button to confirm the selection, then press the **PTT** switch or the **Side** button to return to the operation mode.

TRANSMIT POWER

You can adjust the transmit power on all channels. Selecting low power will allow longer use of the battery pack. Selecting high power will allow you to transmit further, in case the other party is too far away for low power usage.

To change the transmit power:

- 1 Enter the Channel setup mode {p.15}.
- 2 Press the ▲ or ▼ button to select “ $t-P_{WR}$ ”.



- 3 Press the **Menu** button then press the ▲ or ▼ button to select your desired value.

H	High	Switch transmit power to 2.0 W. (icon : ■■■)
L	Low	Switch transmit power to 1.0 W. (icon : ■)

- The ■■■ icon appears on the display when Transmission.
- 4 Press the **Menu** button to confirm the selection, then press the **PTT** switch or the **Side** button to return to the operation mode.

PRIVACY TALK

Scrambler (Analog)

When the Channel Type is Analog, whereas the QT and DQT functions allow you to ignore unwanted calls, Privacy Talk allows you to hold a conversation in complete privacy. When this function is activated, any other party that is listening to your channel will be unable to understand your conversation.

- 1 Enter the Channel setup mode {p.15}.
- 2 Press the ▲ or ▼ button to select “ SCR (Analog) ”.



- 3 Press the **Menu** button then press the ▲ or ▼ button to select your desired value.

off	OFF	The Scrambler (Analog) function is deactivate.
on	ON	The Scrambler (Analog) function is activate.

- The PRIVACY icon appears on the display when “ON” is selected.
- 4 Press the **Menu** button to confirm the selection, then press the **PTT** switch or the **Side** button to return to the operation mode.

Encryption (Digital)

When the Channel Type is Digital (NXDN), encryption can be performed by using the encryption key during voice call, and further communication with enhanced confidentiality can be performed.

1 Enter the Setting mode {p.37}.

2 Press the ▲ or ▼ button to select “ENCKEY”.



3 Press the **Menu** button then press the ▲ or ▼ button to select the encryption key code from 1 to 32767.

4 Enter the Channel setup mode {p.15}.

5 Press the ▲ or ▼ button to select “ENCPYP(Digital)”.



6 Press the **Menu** button then press the ▲ or ▼ button to select your desired value.

off	OFF	The Encryption (Digital) function is deactivate.
on	ON	The Encryption (Digital) function is activate.

- The **PRIVACY** icon appears on the display when “ON” is selected.

7 Press the **Menu** button to confirm the selection, then press the **PTT** switch or the **Side** button to return to the operation mode.

Note:

- ◆ Please match channel number, group number, or Encryption key setting with the other party. Calls can not be made unless all settings match.
-

PTT ID (Analog FleetSync)/ SELCALL ON PTT (Digital NXDN)

The transceiver can send a PTT ID signal when pressing the PTT switch (beginning of transmission) or when pressing and releasing (beginning of transmission and end of transmission) the PTT switch.

When you use the Caller ID Display function {p.50}, when the transceiver receives a PTT ID signal, the caller ID of that signal appears on the display, so you know who is making the call.

- 1 Enter the Channel setup mode {p.15}.
- 2 Press the ▲ or ▼ button to select "Ptt Id".



- 3 Press the **Menu** button then press the ▲ or ▼ button to select your desired value.

off	OFF	PTT ID is not sent.
bot	BOT	Send the PTT ID at the beginning of transmission.
LO1~L99	List 01 ~ List 99	Send selected list ID number PTT ID at the beginning and end of transmission.
PSUCPP	Reserved Group	You can select a Reserved Group and talk. It can be selected when Channel type is Digital or Mixed and Transmit mode is Digital.

- 4 Press the **Menu** button to confirm the selection, then press the **PTT** switch or the **Side** button to return to the operation mode.

Note:

- ◆ Transceiver's individual ID number is not available for selection as PTT ID.

COMPANDER

The compander (compressor/expander) allows higher clarity of signals, avoiding excessive noise and interference. When activated, transmitted signals are compressed before being sent and received signals are expanded when they arrive.

This function is activate when Channel type is Analog.

- 1 Enter the Channel setup mode {p.15}.
- 2 Press the ▲ or ▼ button to select "CmPd".



- 3 Press the **Menu** button then press the ▲ or ▼ button to select your desired value.

off	OFF	The Compander function is deactivate.
on	ON	The Compander function is activate.

- The  icon appears on the display when “ON” is selected.

4 Press the **Menu** button to confirm the selection, then press the **PTT** switch or the **Side** button to return to the operation mode.

Note:

- ◆ Please match compander function setting (On/ Off) with the other party. The function can not be enabled unless the settings match.

MONITOR

Press to deactivate signaling (QT/DQT, FleetSync signaling, NXDN, etc.). Press this button again to return to normal operation.



MONITOR BUTTON SETUP





You can set up the transceiver **Side** button or **Menu** button to perform **MONITOR** functions.

Monitor: Press this button to allows you to turn the transceiver signaling off, to listen to all calls that are received on the channel.

Monitor Momentary: Press and hold this button to momentarily turn the transceiver signaling off. Releasing this key turns the transceiver signaling back on. While signaling is off, you can listen to all calls that are received on the channel.

To set up the **MONITOR** button:

- 1** Enter the Setting mode {p.37}.
- 2** Press the  or  button to select “*Side*” (Side) or “*mEnU*” (Menu).



- 3** Press the **Menu** button then press  or  button to select “*mon*” (Monitor function assignment) or “*mon m*” (Monitor momentary function assignment).



To return to normal operation, release the **MONITOR** button.

SQUELCH OFF

When no signals are present, the squelch on the transceiver automatically mutes the speaker so you will not hear background noise. Using the **SQUELCH OFF** button, you can open the squelch to unmute the speaker. This allows you to:

- Confirm the channel activity so you don't make a call while another party is using the same channel

SQUELCH OFF BUTTON SETUP

You can set up the transceiver **Side** button or **Menu** button to perform **SQUELCH OFF** functions.

Squelch OFF: Press to hear background noise. Press this key again to return to normal operation.

Squelch OFF Momentary: Continuously hold down this key to hear background noise. Release this key to return to normal operation.

To set up the **SQUELCH OFF** button:

1 Enter the Setting mode {p.37}.

2 Press the ▲ or ▼ button to select “SIDE” (Side) or “MENU” (Menu).



3 Press the **Menu** button then press ▲ or ▼ button to select “SQL” (Squelch off function assignment) or “SQL m” (Squelch off momentary function assignment).



To manually open the squelch, press and hold the **SQUELCH OFF** button.

- When squelch is open, the  icon appears on the display and the LED lights green.



To return to normal operation, release the **SQUELCH OFF** button.

SIGNALING

QUIET TALK/ DIGITAL QUIET TALK (Analog)

QT (Quiet Talk) and DQT (Digital Quiet Talk) are functions that reject signals from undesired parties that are using the same channel as you. You will hear audio from the speaker only when you receive a signal that contains a tone or code matching the one set up on the channel you are using. Likewise, when you transmit on a channel set up with QT or DQT, the receiving station must have a matching tone or code in order to hear your signal.

You can select a tone or code for each channel. There are 45 QT tones and 174 DQT codes. After changing the QT/ DQT setting, confirm that the other members in your group have selected the same tone or code.

QT No.	QT Frq.	QT No.	QT Frq.	QT No.	QT Frq.	QT No.	QT Frq.
1	67.0 Hz	13	103.5 Hz	25	156.7 Hz	37	241.8 Hz
2	71.9 Hz	14	107.2 Hz	26	162.2 Hz	38	250.3 Hz
3	74.4 Hz	15	110.9 Hz	27	167.9 Hz	39	69.3 Hz
4	77.0 Hz	16	114.8 Hz	28	173.8 Hz	40	67.0 Hz
5	79.7 Hz	17	118.8 Hz	29	179.9 Hz	41	67.0 Hz
6	82.5 Hz	18	123.0 Hz	30	186.2 Hz	42	67.0 Hz
7	85.4 Hz	19	127.3 Hz	31	192.8 Hz	43	67.0 Hz
8	88.5 Hz	20	131.8 Hz	32	203.5 Hz	44	67.0 Hz
9	91.5 Hz	21	136.5 Hz	33	210.7 Hz	45	67.0 Hz
10	94.8 Hz	22	141.3 Hz	34	218.1 Hz	oFF	OFF
11	97.4 Hz	23	146.2 Hz	35	225.7 Hz		
12	100.0 Hz	24	151.4 Hz	36	233.6 Hz		

DQT No.	DQT Code	DQT No.	DQT Code	DQT No.	DQT Code	DQT No.	DQT Code	DQT No.	DQT Code
1	D023N	21	D134N	41	D306N	61	D503N	81	D734N
2	D025N	22	D143N	42	D311N	62	D506N	82	D743N
3	D026N	23	D152N	43	D315N	63	D516N	83	D754N
4	D031N	24	D155N	44	D331N	64	D532N	84	D645N
5	D032N	25	D156N	45	D343N	65	D546N	85	D023I
6	D043N	26	D162N	46	D346N	66	D565N	86	D025I
7	D047N	27	D165N	47	D351N	67	D606N	87	D026I
8	D051N	28	D172N	48	D364N	68	D612N	88	D031I
9	D054N	29	D174N	49	D365N	69	D624N	89	D032I
10	D065N	30	D205N	50	D371N	70	D627N	90	D043I
11	D071N	31	D223N	51	D411N	71	D631N	91	D047I
12	D072N	32	D226N	52	D412N	72	D632N	92	D051I
13	D073N	33	D243N	53	D413N	73	D654N	93	D054I
14	D074N	34	D244N	54	D423N	74	D662N	94	D065I
15	D114N	35	D245N	55	D431N	75	D664N	95	D071I
16	D115N	36	D251N	56	D432N	76	D703N	96	D072I
17	D116N	37	D261N	57	D445N	77	D712N	97	D073I
18	D125N	38	D263N	58	D464N	78	D723N	98	D074I
19	D131N	39	D265N	59	D465N	79	D731N	99	D114I
20	D132N	40	D271N	60	D466N	80	D732N	100	D115I

DQT No.	DQT Code	DQT No.	DQT Code	DQT No.	DQT Code	DQT No.	DQT Code	DQT No.	DQT Code
101	D116I	116	D226I	131	D351I	146	D506I	161	D712I
102	D125I	117	D243I	132	D364I	147	D516I	162	D723I
103	D131I	118	D244I	133	D365I	148	D532I	163	D731I
104	D132I	119	D245I	134	D371I	149	D546I	164	D732I
105	D134I	120	D251I	135	D411I	150	D565I	165	D734I
106	D143I	121	D261I	136	D412I	151	D606I	166	D743I
107	D152I	122	D263I	137	D413I	152	D612I	167	D754I
108	D155I	123	D265I	138	D423I	153	D624I	168	D645I
109	D156I	124	D271I	139	D431I	154	D627I	169	D023N
110	D162I	125	D306I	140	D432I	155	D631I	170	D023N
111	D165I	126	D311I	141	D445I	156	D632I	171	D023N
112	D172I	127	D315I	142	D464I	157	D654I	172	D023N
113	D174I	128	D331I	143	D465I	158	D662I	173	D023N
114	D205I	129	D343I	144	D466I	159	D664I	174	D023N
115	D223I	130	D346I	145	D503I	160	D703I	oFF	OFF

- 1 Enter the Channel setup mode {p.15}.
- 2 Press the ▲ or ▼ button to select “QTDQT”.

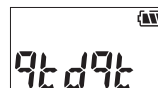

- 3 Press the **Menu** button then press the ▲ or ▼ button to select your desired value.
 - The values range from 1 to 45 for QT tones, then proceed to 1 to 174 for DQT codes. When selecting a DQT code, the **DQT** icon appears on the display.
 - Select “OFF” to turn off both QT and DQT.



- 4 Press the **Menu** button to exit the selection.

RAN (RADIO ACCESS NUMBER)

RAN is a signaling system designed for Digital transceiver communications. When a channel is set up with a RAN, squelch will only open when a call containing a matching RAN is received. If a call containing a different RAN is made on the same channel you are using, you will not hear the call. This allows you to ignore (not hear) calls from another parties who are using the same channel.

- 1 Enter the Channel setup mode {p.15}.
- 2 Press the ▲ or ▼ button to select “RAn”.



- 3 Press the **Menu** button then press the ▲ or ▼ button to select your desired value.

off	OFF	RAN is not set.
1 ~ 63	1~63	You can set 1 to 63 RAN.

- 4 Press the **Menu** button to confirm the selection, then press the **PTT** switch or the **Side** button to return to the operation mode.

FleetSync: ALPHANUMERIC 2-WAY PAGING FUNCTION

FleetSync is an Alphanumeric 2-way Paging Function, and is a protocol owned by JVC KENWOOD Corporation.

Note:

- ◆ This function is available only in analog operation.

SELCALL MODE (SELECTIVE CALLING)

A Selcall is a voice call to a particular station or group of stations.

Each transceiver is set up with an individual ID number for use with Selcalls.

There are several types of Selcalls available: Individual, Group, and Broadcast.

- Individual Calls are calls made to individual parties.
- Group Calls are calls made to all parties within a group.
- Broadcast Calls are calls made to all parties in all groups.

The default status of the transceiver does not allow you to make a Selcall.

Use the following procedures to set up your transceiver to allow Selcalls:

Step 1: Activate the FleetSync Optional Signaling

- 1 Enter the Setting mode {p.37}.
- 2 Press the ▲ or ▼ button to select “oP 5iG”.



- 3 Press the **Menu** button then press the ▲ or ▼ button to select your desired value.

oFF	OFF	The Selcall function by FleetSync is deactivate.
F 5	FleetSync	The Selcall function by FleetSync is activate

- After setting the Optional Signaling to FleetSync, you will no longer be able to receive calls except selcalls.

Step 2: Set up your own ID (ID List Setting mode for Selcall)

- 1 With the transceiver power OFF, press and hold while turning the transceiver power ON.



- A beep will sound and the transceiver will enter ID List Setting mode.
- It can not be set unless editing in ID List Setting mode is permitted on the FPU.

- 2 Press the ▲ or ▼ button to select a List ID number.

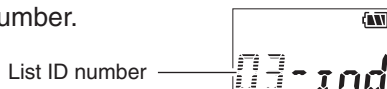

3 Press the **Menu** button then press the ▲ or ▼ button to select List ID type.



- List ID type has the following settings.
 - “*Ind*” represents an Individual Call ID.
 - “*GRP*” represents a Group Call ID.
 - “*ALL*” represents a Broadcast Call ID.
 - “*own*” represents your own ID number.
- The default own ID setting is List 01.
- When setting up your own ID, make sure that each member within your group sets up a unique ID number for their own ID. If an own ID number is duplicated, that transceiver cannot perform individual calls to other transceivers with the same own ID.

4 Press the **Menu** button to confirm the selection.

5 Press the **PTT** switch or the **Side** button to exit ID List Setting mode.



MAKING A SELCALL

Following are details on how to make individual, group, and broadcast calls. Refer to the diagram below for the examples provided herein.

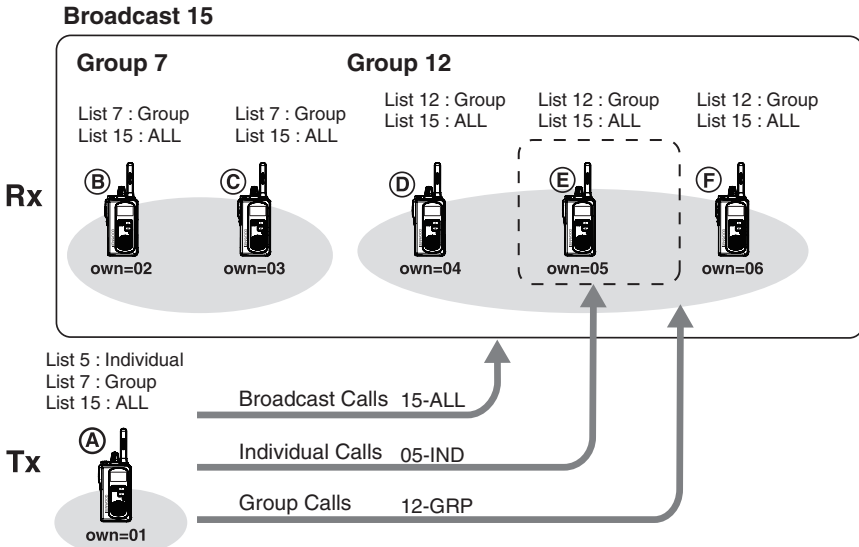

Note:

- ◆ When QT/DQT is set to the receiving side, the call side QT/DQT settings must be set up the same as the receiving side settings.

GROUP CALLS:

For example, transceiver A is calling transceivers D, E, and F.

- 1 Press and hold the **Side** button. or press the button programmed as [ID List].
 - The ID List you called last is displayed.
- 2 Press the ▲ or ▼ button to select an Group ID number (12-GRP in this example).
 - “GRP” (Group Call) represents a group of stations.
- 3 Press the **PTT** switch to transmit the selected ID.
 - When a call is received, “GRP” appears on the display, along with the caller’s ID number.

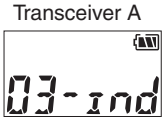

INDIVIDUAL CALLS:

For example, transceiver A is calling transceiver E.

- 1 Press and hold the **Side** button. or press the button programmed as [ID List].
 - The ID List you called last is displayed.
- 2 Press the ▲ or ▼ button to select an Individual ID number (05-IND in this example).
 - “Ind” (Individual Call) represents a single station.
- 3 Press the **PTT** switch to transmit the selected ID.
 - When a call is received, “Ind” appears on the display, along with the caller’s ID number.

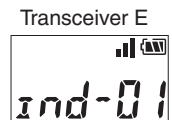
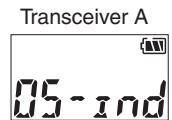
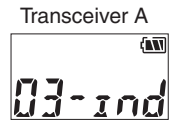

BROADCAST CALLS:

For example, transceiver A is calling transceivers B ~ F.

- 1 Press and hold the **Side** button. or press the button programmed as [ID List].
 - The ID List you called last is displayed.
- 2 Press the ▲ or ▼ button to select an Broadcast ID number (ALL-15 in this example).
 - “ALL” (Broadcast Call) represents a group of stations.
- 3 Press the **PTT** switch to transmit the selected ID.
 - When a call is received, “ALL” appears on the display, along with the caller’s ID number.

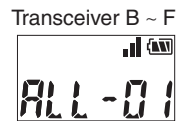
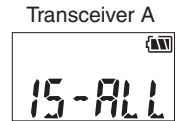
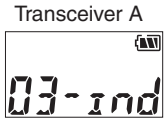

RECEIVING A SELCALL

When a selcall is received, “Ind”, “GRP” or “ALL” appears on the display along with the caller's ID number.



Press the **PTT** switch and speak into the speaker area to respond to the call, then continue the call as normal. When the call is finished, Press and hold the **Side** button to return to operating mode.

NXDN

NXDN is a general term for the NXDN wireless communication protocol which uses 4 Level FSK. Various digital communications, including individual and group voice communications are possible.

SELCALL MODE (SELECTIVE CALLING)

The basic operation is the same as Selcall in FleetSync.

Step 1: Set up your own ID (ID List Setting mode for Selcall)

1 With the transceiver power OFF, press and hold while turning the transceiver power ON.

- A beep will sound and the transceiver will enter ID List Setting mode.
- It can not be set unless editing in ID List Setting mode is permitted on the FPU.



2 Press the ▲ or ▼ button to select a list ID number.

List ID number



3 Press the **Menu** button then press the ▲ or ▼ button to select List ID type.

- List ID type has the following settings.
 - “ ind ” represents an Individual Call ID.
 - “ GRP ” represents a Group Call ID.
 - “ ALL ” represents a ALL Group Call ID.
 - “ own ” represents your own ID number.
- The default own ID setting is List 01.
- When setting up your own ID, make sure that each member within your group sets up a unique ID number for their own ID. If an own ID number is duplicated, that transceiver cannot perform individual calls to other transceivers with the same own ID.



List ID type

4 Press the **Menu** button to confirm the selection.

5 Press the **PTT** switch or the **Side** button to exit ID List Setting mode.



GROUP CALLS:

This function to make calls by calling group parties. Select an ID from a pre-registered list and call another group parties.

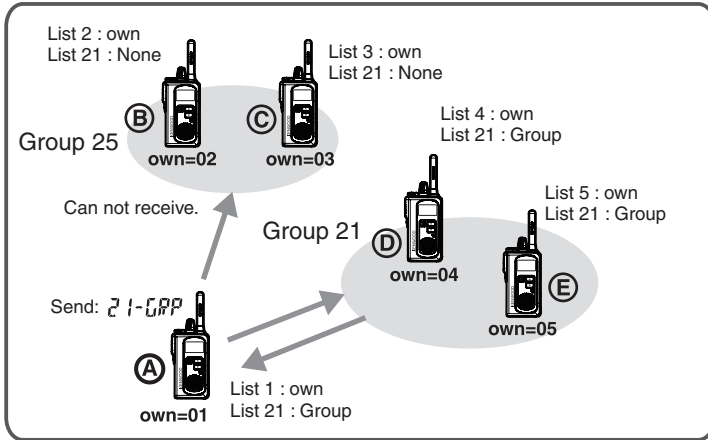

To operation the Group Call:

- 1 Press and hold the **Side** button, or press the button programmed as [ID List].
 - The ID List you called last is displayed.
- 2 Press the ▲ or ▼ button to select an group ID number (21-GRP in this example).
 - “GRP” (group call) represents a group of stations.
- 3 Press the **PTT** switch to transmit the selected ID.
 - When a call is received, “GRP” appears on the display, along with the caller’s ID number.

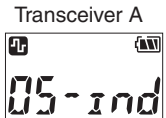

INDIVIDUAL CALLS:

It is a function to make calls by calling individual parties. Select an ID from a pre-registered list and call another parties.

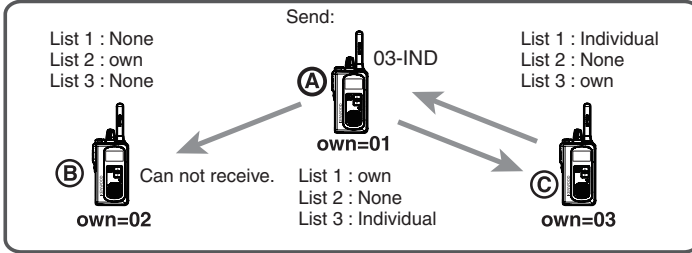

To operation the Individual Call:

- 1 Press and hold the **Side** button, or press the button programmed as [ID List].
 - The ID List you called last is displayed.
- 2 Press the ▲ or ▼ button to select an individual ID number (03-IND in this example).
 - “*ind*” (individual call) represents a single station.
- 3 Press the **PTT** switch to transmit the selected ID.
 - When a call is received, “*ind*” appears on the display, along with the caller’s ID number.

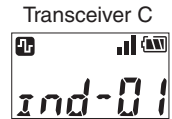
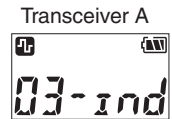
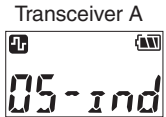

ALL GROUP CALLS (BROADCAST CALLS) :

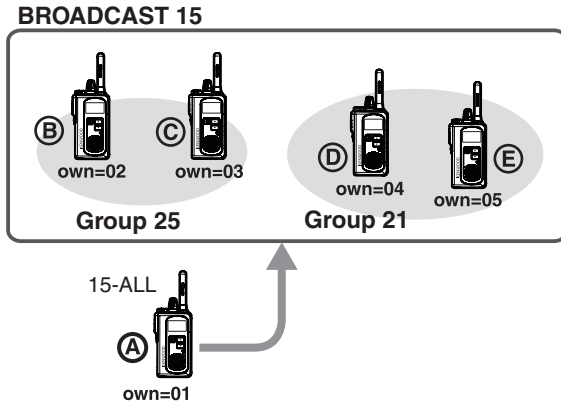

To operation the ALL Group Call:

- 1** Press and hold the **Side** button, or press the button programmed as [ID List].
 - The ID List you called last is displayed.
- 2** Press the ▲ or ▼ button to select an ALL Group ID number.
 - “ALL” (ALL Group Call) represents a group of stations.
- 3** Press the **PTT** switch to transmit the selected ID.
 - When a call is received, “ALL” appears on the display, along with the caller’s ID number.

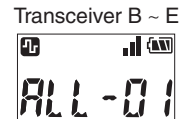
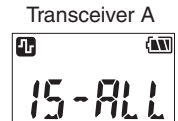
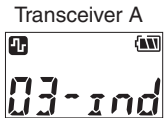

VOICE OPERATED TRANSMISSION (VOX)

Using the VOX feature, you can operate the transceiver hands-free. In order to use this feature, however, you must use an optional headset; VOX will not function with the built-in microphone. For best operation conditions, we recommend you use an optional headset with both an ear piece and a microphone on a boom that rests in front of your mouth.

Set the VOX and the VOX Gain level, perform the following steps:

VOX OPERATION

Note:

- ◆ To use the VOX function, you need to set the VOX GAIN LEVEL and VOX DELAY TIME to set up in Setting mode {p.59}.

1 Set up a VOX gain level from “1” to “10”.

2 Connect a headset to the transceiver.

- The VOX function does not activate when a headset is not connected to the SP/MIC jack of the transceiver.

3 Enter the Channel setup mode {p.15}

4 Press the ▲ or ▼ button to select “10”.



5 Press the **Menu** button then press ▲ or ▼ to select “on” (VOX function activate) .



6 Press the **Menu** button to confirm the selection, then press the **PTT** switch or the **Side** button to return to the operation mode.

7 To transmit, speak into the headset.

- You do not need to press the **PTT** switch; the transceiver automatically detects your voice and begins transmitting. The LED lights red.

8 To stop transmitting, stop speaking.

- Transmission will continue momentarily after you stop speaking. You can select the delay time as described on p.60.

9 To exit VOX mode, set the VOX to “off” (VOX function deactivate).



Note:

- ◆ If a headset is connected to the transceiver while the VOX function is switched ON and the VOX Gain level is configured to a higher, more sensitive level, louder received signals may cause the transceiver to start transmitting.

SCAN

Scan is useful for monitoring signals on the transceiver channels. When scanning, the transceiver checks for a signal on each channel and only stops if a signal is present.

If the QT/ DQT/ RAN matches, the transceiver stops at the channel and opens the squelch so you can listen to the call. If the QT/ DQT/ RAN does not match, the call is ignored and scanning continues.

Before you can use the scan function, ensure that it is activated. You can turn the scan function (the ability to perform scan) ON or OFF in Setting mode.

SCAN BUTTON SETUP

You can set up the transceiver **Side** button or **Menu** button to perform SCAN functions.

SCAN: Press this button to start scanning the transceiver channels.

Scan Delete/ Add: Adds or removes the selected Channel to or from the scan sequence.

To set up the **SCAN** button:

- 1 Enter the Setting mode {p.37}.
- 2 Press the ▲ or ▼ button to select “Side” (Side) or “mEnU” (Menu).
- 3 Press the **Menu** button then press ▲ or ▼ button to select “SCAN”.



SCAN OPERATION

To begin scanning:

- 1 To begin scanning, press the button set for scan.
 - The indicator appears on the display.
 - The channels are scanned.
- 2 When the signal is detected and the QT/ DQT/ RAN matches, the channel number is displayed on the display and the SCAN icon blinks.
- 3 When the signal is no longer present, the transceiver waits for 3 seconds before scanning continues.
 - If a new signal appears before the 3 seconds elapse, the transceiver will remain on the channel until the new signal is no longer present, at which time it will again wait for 3 seconds before continuing.



4 To end the scan at any time, press the button programmed as Scan button.

- The transceiver returns to the channel you were using before you started scanning.

REVERT CHANNEL

The revert channel is the channel from which you start scanning. So, for example, if you are on channel 1 when you begin to scan, your revert channel is channel 1.

During scan, pressing the **PTT** switch will automatically select the transceiver's revert channel (in the above example, channel 1) and you will begin transmitting. However, if you are currently paused on another channel after having received a signal (for example, channel 2), pressing the **PTT** switch will allow you to transmit on that channel, rather than returning to the revert channel. Scanning will resume after 3 seconds, unless a signal is present on the channel.

LOCK FUNCTION

BUTTON LOCK

You can lock the **Menu**, ▲, and ▼ buttons to prevent accidentally changing the operating mode and channel settings. The **Power** switch/ **Volume** control and **PTT** still function normally.

Press and hold the **Menu** button for 1 seconds to lock or unlock the transceiver buttons.



- The  icon appears on the display when the transceiver buttons are locked. No icon appears when they are unlocked.

SUPER LOCK

You can lock other than **PTT** switch, ▲/ ▼ buttons, or the **Power** switch/ **Volume** control to prevent accidentally changing the setting mode settings. If necessary, it is also possible to avoid locking for the functions shown below.

To select the super lock setting:

- 1 With the transceiver power OFF, press and hold the **PTT** switch and the **Side** button while turning the transceiver power ON.
- 2 Press the **Menu** button then press the ▲ or ▼ button to select your desired value.



SL-off	The Super Lock function is deactivate.	
SL-PTT	With this setting, the following operations are still available even during Super Lock.	
	<ul style="list-style-type: none"> • Power-switch/ Volume control • PTT switch • Calling Alert • Monitor 	<ul style="list-style-type: none"> • Monitor Momentary • Second PTT • Squelch Off • Squelch Off Momentary
SL-CH	During Super Lock, the following buttons are still available in addition to setting in SL-PTT.	
	<ul style="list-style-type: none"> • Channel Up • Channel Up (Continuous) • Channel Down • Channel Down (Continuous) 	<ul style="list-style-type: none"> • Home Channel

- 3 Press the **Menu** button, **PTT** switch, or **Side** button to exit Super Lock Setting mode.
 - The  icon appears on the display when the transceiver buttons are locked. No icon appears when they are unlocked.

SETTING MODE

Many functions on this transceiver are selected or configured through the Menu instead of physical controls.

- 1 With the transceiver power OFF, press and hold the **Menu** button while turning the transceiver power ON.
- 2 Press the ▲ or ▼ button to select your desired Setting menu. 
- 3 Press the **Menu** button then press the ▲ or ▼ button to select your desired value.



- 4 Press the **Menu** button to exit the selection.
- 5 Press the **PTT** switch or the **Side** button to exit Setting mode.

Setting Menu LIST

Display	Name	Analog	Digital	Settings	Default	Ref. Pg
CH 1~ CH 6	Channel 1 ~ Channel 6 Frequency Setting	✓	✓	OFF/ Frequency 1 ~ Frequency 99		39
CH 7~ CH 16	Channel 7 ~ Channel 16 Frequency Setting	✓	✓	OFF/ Frequency 1 ~ Frequency 99		39
P no	Profile Number		✓	0 ~ 9	0	40
oP SiG	Optional Signaling (Analog)	✓		OFF/ FS (FleetSync)	OFF	25
i tonE	Individual Selcall Alert tone (Analog)	✓	✓	OFF/ 1 ~ 8	3	40
G tonE	Group Selcall Alert tone (Analog)	✓	✓	OFF/ 1 ~ 8	4	41
i LED	Individual Selcall Alert LED color	✓	✓	OFF/ Yellow/ Purple/ Blue/ Light Blue/ Red/ Green/ White	Yellow	41
G LED	Group Selcall Alert LED color	✓	✓	OFF/ Yellow/ Purple/ Blue/ Light Blue/ Red/ Green/ White	Yellow	42
Et	Incoming Call Notification	✓	✓	OFF/ ON	OFF	43
Side	Button Assignment [Side]	✓	✓	Refer to the Functions list	Individual Reply	44
mEnU	Button Assignment [Menu]	✓	✓	Refer to the Functions list	Channel Menu	44

Display	Name	Analog	Digital	Settings	Default	Ref. Pg.
CA	Call Alert Tone	✓		1 ~ 16	1	46
Home	Home Channel	✓	✓	OFF/ 1 ~ 16	OFF	46
2nd CH	Second Channel	✓	✓	OFF/ 1 ~ 16	OFF	47
TL	Transmit Tone Level	✓	✓	-20 dB ~ 0 dB	0 dB	49
PTT ID	PTT ID Side Tone	✓		OFF/ ON	ON	49
CID	Caller ID Display (FleetSync/ NXDN)	✓	✓	OFF/ ON	OFF	50
PTT Hd	PTT Hold	✓	✓	OFF/ ON/ 2-times	OFF	50
Mode RST	Mode Reset Timer	✓	✓	OFF/ 1 ~ 300 sec	10 sec	51
TO	Time-out Timer	✓	✓	15 ~ 600 sec	60 sec	51
BCL	Busy Channel Lockout	✓	✓	OFF/ ON	OFF	52
INC	Incorrect Signaling Notification	✓	✓	OFF/ ON	OFF	52
BL	Backlight	✓	✓	OFF/ Active/ Any/ ON	Active	53
Battery Saver	Battery Saver	✓	✓	OFF/ Short/ Medium/ Long	OFF	54
Beep	Beep Tone	✓	✓	OFF/ 1 ~ 31/ Volume	Volume	55
SQ	Squelch Level	✓		0/ 1/ 2/ 3	2	55
MIC	Microphone Sense	✓	✓	-20 dB ~ 6 dB	0 dB	56
Ext MIC	External Microphone Sense	✓	✓	-20 dB ~ 6 dB	0 dB	56
Mic Type	Mic Type		✓	OFF/ 1 ~ 6	1	57
RX EQ	RX Audio Equalizer		✓	Low Boost/ Flat / High Boost	Flat	58
TX EQ	TX Audio Equalizer		✓	Low Boost/ Flat / High Boost	Flat	58
ENCRY	Encryption key data		✓	1 ~ 32767	1	59
VOX Gain	VOX Gain Level	✓	✓	1 ~ 10	5	59
VOX DELAY	VOX Delay Time	✓	✓	0.1/ 0.3/ 0.5/ 1.0/ 1.5/ 3.0 sec	0.5 sec	60
TI	Transmit Inhibit while Receiving	✓	✓	OFF/ ON	OFF	60
VOX PPT	VOX Proceed Tone	✓	✓	OFF/ ON	OFF	61
EARPHONE	Earphone mode	✓	✓	OFF/ ON	OFF	62
Power LED	Selectable Power ON LED color	✓	✓	OFF/ Yellow/ Purple/ Blue/ Light Blue/ Red/ Green/ White	OFF	63
Power Tone	Selectable Power ON Tone	✓	✓	1 ~ 4	2	64

CHANNEL FREQUENCY SETUP

You can change the default frequency of each channel.

- 1 Enter the Setting mode {p.37}.
- 2 Press the ▲ or ▼ button to select a channel.
 - The current frequency table number appears beside the channel number.
- 3 Press the **Menu** button then press the ▲ or ▼ button to select the frequency table number for the channel.
- 4 Press the **Menu** button to exit the selection, then repeat steps 2 and 3 to set additional channels.



Frequency LIST

Table No.	Frg. (MHz)	Table No.	Frg. (MHz)	Table No.	Frg. (MHz)	Table No.	Frg. (MHz)
1	464.5000	26	462.8375	51	467.8875	76	452.7625
2	464.5500	27	462.8625	52	467.9125	77	452.8625
3	467.7625	28	462.8875	53	469.4875	78	456.1875
4	467.8125	29	462.9125	54	469.5125	79	456.2375
5	467.8500	30	464.4875	55	469.5375	80	456.2875
6	467.8750	31	464.5125	56	469.5625	81	468.2125
7	467.9000	32	464.5375	57	462.1875	82	468.2625
8	467.9250	33	464.5625	58	462.4625	83	468.3125
9	461.0375	34	466.0375	59	462.4875	84	468.3625
10	461.0625	35	466.0625	60	462.5125	85	468.4125
11	461.0875	36	466.0875	61	467.1875	86	468.4625
12	461.1125	37	466.1125	62	467.4625	87	468.5125
13	461.1375	38	466.1375	63	467.4875	88	468.5625
14	461.1625	39	466.1625	64	467.5125	89	468.6125
15	461.1875	40	466.1875	65	451.1875	90	468.6625
16	461.2125	41	466.2125	66	451.2375	91	456.3375
17	461.2375	42	466.2375	67	451.2875	92	456.4375
18	461.2625	43	466.2625	68	451.3375	93	456.5375
19	461.2875	44	466.2875	69	451.4375	94	456.6375
20	461.3125	45	466.3125	70	451.5375	95	457.3125
21	461.3375	46	466.3375	71	451.6375	96	457.4125
22	461.3625	47	466.3625	72	452.3125	97	457.5125
23	462.7625	48	467.7875	73	452.5375	98	457.7625
24	462.7875	49	467.8375	74	452.4125	99	457.8625
25	462.8125	50	467.8625	75	452.5125		

PROFILE NUMBER

Profile number is a calling method that enables multiple users to hear only the voice of a users that has the same Profile number when multiple users are using the same channel.

- 1 Enter the Setting mode {p.37}.
- 2 Press the ▲ or ▼ button to select “P no”.



- 3 Press the **Menu** button then press the ▲ or ▼ button to select your desired value.

0 ~ 9	0 ~ 9	The selected number is set to Profile number.
-------	-------	---

- 4 Press the **Menu** button to confirm the selection, then press the **PTT** switch or the **Side** button to return to the operation mode.

INDIVIDUAL CALL ALERT TONE

Sets the alert tone when called with Individual Call.

- 1 Enter the Setting mode {p.37}.
- 2 Press the ▲ or ▼ button to select “i tone”.



- 3 Press the **Menu** button then press the ▲ or ▼ button to select your desired value.

off	OFF	Does not output alert tone.
1 ~ 8	1 ~ 8	Select from 8 type tones.

- The Alert tone stops when the set time elapses, or when any button is operated.
- 4 Press the **Menu** button to confirm the selection, then press the **PTT** switch or the **Side** button to return to the operation mode.

GROUP CALL ALERT TONE

Sets the alert tone when called on the Group Call or Broadcast Call (All Call).

- 1 Enter the Setting mode {p.37}.
- 2 Press the ▲ or ▼ button to select “G tone”.



- 3 Press the **Menu** button then press the ▲ or ▼ button to select your desired value.

<i>off</i>	OFF	Does not output alert tone.
<i>1 ~ 8</i>	1 ~ 8	Select from 8 type tones.

- The Alert tone stops when the set time elapses, or when any button is operated.
- 4 Press the **Menu** button to confirm the selection, then press the **PTT** switch or the **Side** button to return to the operation mode.

INDIVIDUAL CALL ALERT LED COLOR

This function is set the color of the blinking LED when it is received with individual call.

- 1 Enter the Setting mode {p.37}.
- 2 Press the ▲ or ▼ button to select “I LED”.



- 3 Press the **Menu** button then press the ▲ or ▼ button to select your desired value.

<i>off</i>	OFF	Even if the received with individual call, the LED does not blinking up.
<i>YEL</i>	Yellow	When the received with individual call, the LED will blinking yellow.
<i>PPL</i>	Purple	When the received with individual call, the LED will blinking purple.
<i>BLU</i>	Blue	When the received with individual call, the LED will blinking blue.
<i>L BLU</i>	Light Blue	When the received with individual call, the LED will blinking light blue.
<i>RED</i>	Red	When the received with individual call, the LED will blinking red.
<i>GRN</i>	Green	When the received with individual call, the LED will blinking green.
<i>WHT</i>	White	When the received with individual call, the LED will blinking white.

- 4 Press the **Menu** button to confirm the selection, then press the **PTT** switch or the **Side** button to return to the operation mode.

GROUP CALL ALERT LED COLOR

This function is set color of the blinking LED when transmitting and receiving with the group call.

- 1 Enter the Setting mode {p.37}.
- 2 Press the ▲ or ▼ button to select “G LED”.



- 3 Press the **Menu** button then press the ▲ or ▼ button to select your desired value.

<i>off</i>	OFF	Even if transmitting and receiving with the group call, the LED does not blinking up.
<i>YEL</i>	Yellow	When transmitting and receiving with the group call, the LED will blinking yellow.
<i>PPL</i>	Purple	When transmitting and receiving with the group call, the LED will blinking purple.
<i>BLU</i>	Blue	When transmitting and receiving with the group call, the LED will blinking blue.
<i>L BLU</i>	Light Blue	When transmitting and receiving with the group call, the LED will blinking light blue.
<i>RED</i>	Red	When transmitting and receiving with the group call, the LED will blinking red.
<i>GRN</i>	Green	When transmitting and receiving with the group call, the LED will blinking green.
<i>WHT</i>	White	When transmitting and receiving with the group call, the LED will blinking white.

- 4 Press the **Menu** button to confirm the selection, then press the **PTT** switch or the **Side** button to return to the operation mode.

INCOMING CALL NOTIFICATION

Note:

- ◆ To use Incoming Call Notification, you must set up a QT tone or a DQT code {page 18}.

Incoming Call Notification is used to inform you of when a call is being received. When activated, a tone is emitted when a busy signal is received and the QT/ DQT/ RAN signaling matches.

- The tone will sound for 15 seconds before turning off.
- While the tone sounds, you will not hear any audio from the speaker. Press any button to turn the tone off and listen to the received call.

After the call is finished, the transceiver will wait for 10 seconds before resetting. If you receive a new call within those 10 seconds, the tone will not sound. If no call is received within 10 seconds, Incoming Call Notification will reset so that the next time a call is received, the tone will sound again.

To turn Incoming Call Notification on or off:

- 1 Enter the Setting mode {p.37}.
- 2 Press the ▲ or ▼ button to select “[t]”.



- 3 Press the **Menu** button then press the ▲ or ▼ button to select your desired value.

off	OFF	The Incoming call notification function is deactivate.
on	ON	The Incoming call notification function is activate.

- 4 Press the **Menu** button to confirm the selection, then press the **PTT** switch or the **Side** button to return to the operation mode.

BUTTON ASSIGNMENT

The **Side** and **Menu** buttons can be programmed with the functions listed below.

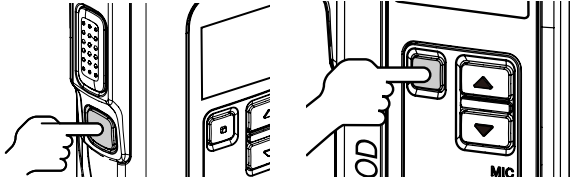

Functions LIST

Function name	Display	Press	Hold
None	<i>none</i>	None	None
Button Lock	<i>LOCK</i>	None	Press to lock/unlock the transceiver buttons. Refer to {p.36}.
Calling Alert	<i>CALL</i>	Calling Alert	None
Channel Down	<i>CH dw</i>	Decreases the Channel number in steps of 1.	Hold down this button to continuously decrease the Channel number.
Channel Menu	<i>MENU</i>	Enter the Channel setup menu. Refer to {p.15}.	Press to lock/unlock the transceiver buttons. Refer to {p.36}.
Channel Up	<i>CH UP</i>	Increases the Channel number in steps of 1.	Hold down this button to continuously increase the Channel number.
CW Message	<i>CW</i>	Press to transmit the preset Morse code message on your current channel. (It can not operate in the initial state.)	None
Fixed Volume	<i>F-VOL</i>	Switches various Tone levels of the transceiver among the settings for High, Low or Off. (It can not operate in the initial state.)	None
Home Channel	<i>HOME</i>	Press this button to immediately select your Home Channel. Refer to {p.46}.	Hold down this button to set the current channel as the Home Channel. Refer to {p.46}.
ID List	<i>IDLIST</i>	To transmit your ID list, to request a call. Refer to {p.25} or {p.29}.	None

Function name	Display	Press	Hold
Individual Reply	<i>IRPLY</i>	When you receive a Group Call, etc., while you are displaying the ID of the caller, you can call Individual Call to the caller by pressing the button that programmed this function and then pressing PTT switch.	None
Maintenance	<i>mnt</i>	Enter Maintenance Display Mode and display the signal strength numerically.	None
Monitor	<i>mon</i>	Turns the transceiver signaling off, to listen to all calls that are received on the channel. Press this button again to turn the transceiver signaling back on. Refer to {p.20}.	None
Monitor Momentary	<i>mon m</i>	Turns the transceiver signaling off while holding down this button. Release this button to turn the transceiver signaling back on. While signaling is off, you can listen to all calls that are received on the channel. Refer to {p.20}.	None
Scan	<i>SCAN</i>	Press this button to start scanning the transceiver channels. Refer to {p.34}.	Adds or removes the selected Channel to or from the scan sequence.
Scan Delete/ Add	<i>SCAN dA</i>	Adds or removes the selected Channel to or from the scan sequence.	None
Second PTT	<i>2nd</i>	Apart from the channel you normally select, you can set up another channel as the main channel with a dedicated PTT switch. Refer to {p.47}.	None
Speaker Attenuation	<i>Att</i>	Speaker Attenuation	None
Squelch Off	<i>SQL</i>	Press to hear background noise. Press this button again to return to normal operation. Refer to {p.20}.	None
Squelch Off Momentary	<i>SQL m</i>	Continuously hold down this key to hear background noise. Release this key to return to normal operation. Refer to {p.20}.	None

CALLING ALERT TONE

Call alert tones are used to identify yourself to your party members. You can set up a call alert tone to one of 16 types. If each party member uses a different call alert tone, it is easy to know who is making the call.

This function is activate when Channel type is Analog.

To set up your own call alert tone:

- 1 Enter the Setting mode {p.37}.
- 2 Press the ▲ or ▼ button to select “*CA*”.



- 3 Press the **Menu** button then press the ▲ or ▼ button to select your desired value.

<i>1 ~ 16</i>	1 ~ 16	Select from 16 type tones.
---------------	--------	----------------------------

- Each time you press ▲ or ▼ to select a call alert tone, the new tone sounds.
- 4 Press the **Menu** button to confirm the selection, then press the **PTT** switch or the **Side** button to return to the operation mode.

HOME CHANNEL

A specific channel can be Main Channel.

HOME BUTTON SETUP

You can set up the transceiver **Side** button or **Menu** button to perform Home channel functions.

To set up the **HOME** button:

- 1 Enter the Setting mode {p.37}.
- 2 Press the ▲ or ▼ button to select “*Side*” (Side) or “*mEnU*” (Menu).



- 3 Press the **Menu** button then press ▲ or ▼ button to select “*Home*”.



HOME CHANNEL OPERATION

- 1 Press the button set for Home channel.
- 2 A beep sounds and "HOME" appears on the display for 1 second.
- 3 If you press button set for Home channel again, it returns to the original setting channel.

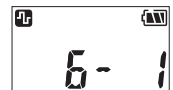

SECOND CHANNEL

Apart from the channel you normally select, you can set up another channel as the main channel with a dedicated **PTT** switch. The PTT for the second channel is set with the key that registered the "second PTT" function using button assignment function in the setting mode.

With the second channel set, it alternately scans the second channel with the channel you normally select.

If there is a received signal, you can stay on that channel and hear the sound.

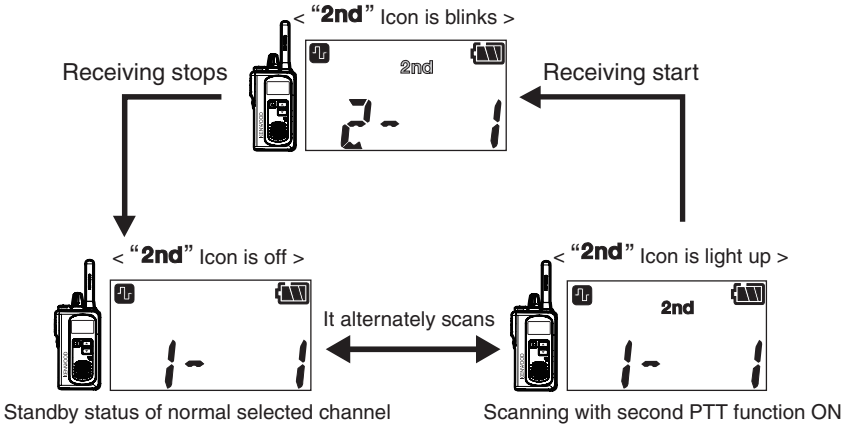

PTT SETUP:

You can set up the transceiver **Side** button or **Menu** button to perform Second PTT functions.

- 1 Enter the Setting mode {p.37}.
- 2 Press the **▲** or **▼** button to select "**Side**" (Side) or "**mEnU**" (Menu).
- 3 Press the **Menu** button then press **▲** or **▼** button to select "**2nd**".



SECOND CHANNEL OPERATION:

- 1 Enter the Setting mode {p.37}.
- 2 Press the ▲ or ▼ button to select "2nd CH".



- 3 Press the **Menu** button then press the ▲ or ▼ button to select your desired value.

off	OFF	The Second PTT function is deactivate.
1 ~ 16	1~16	Select a Second channel.

- 4 When the Second PTT function is activated. "2nd" icon is displayed and scanning starts.
 - When receiving the Second channel, the "2nd" icon blinks and a beep sounds.
- 5 Press the button for the Second PTT function moves to the second channel and transmits on it.
- 6 When the normal selected channel is in the reception state, the "2nd" icon disappears.
 - To transmit on a normal selected channel, press **PTT** switch.

Note:

- ◆ It is recommended to set different QT or DQT (RAN for Digital operation) for the normal selected channel and the second PTT channel respectively.
-

TRANSMIT TONE LEVEL

Adjust the volume on the sender's side if the volume of the alert tone etc. he hears is too loud.

- 1 Enter the Setting mode {p.37}.
- 2 Press the ▲ or ▼ button to select “t L U”.



- 3 Press the **Menu** button then press the ▲ or ▼ button to select your desired value.

L -20db - 18db n 0db	-20 dB(Low level)~ 0 dB(Normal)	Adjust in 2 dB steps. It attenuates the volume by the numerical value.
----------------------------	------------------------------------	---

- 4 Press the **Menu** button to confirm the selection, then press the **PTT** switch or the **Side** button to return to the operation mode.

PTT ID SIDETONE

When press the **PTT** switch to send it, it is a function to notify you that it is ready to talk. It is used to prevent the head of a call from being cut off.

This function is activate when Channel type is Analog.

To turn the PTT ID Sidetone on or off:

- 1 Enter the Setting mode {p.37}.
- 2 Press the ▲ or ▼ button to select “P_{Id} t_o”.



- 3 Press the **Menu** button then press the ▲ or ▼ button to select your desired value.

off	OFF	The PTT ID Sidetone function is deactivate.
on	ON	The PTT ID Sidetone function is activate.

- 4 Press the **Menu** button to confirm the selection, then press the **PTT** switch or the **Side** button to return to the operation mode.

CALLER ID DISPLAY

When the transceiver receives a PTT ID signal, the caller ID of that signal appears on the display, so you know who is making the call.

- 1 Enter the Setting mode {p.37}.
- 2 Press the ▲ or ▼ button to select “*cid*”.



- 3 Press the **Menu** button then press the ▲ or ▼ button to select your desired value.

<i>off</i>	OFF	Even if PTT ID signal is received, the PTT ID is not displayed.
<i>on</i>	ON	When PTT ID signal is received, the PTT ID is displayed

- 4 Press the **Menu** button to confirm the selection, then press the **PTT** switch or the **Side** button to return to the operation mode.

PTT HOLD

It is a function to operate handsfree without using the VOX function. Normally, you keep pushing the **PTT** switch when transmitting, but if you set this function to ON, if you press the **PTT** switch once, the transmission will continue even if you release the **PTT** switch. To stop sending, press the **PTT** switch again.

- 1 Enter the Setting mode {p.37}.
- 2 Press the ▲ or ▼ button to select “*P Hd*”.



- 3 Press the **Menu** button then press the ▲ or ▼ button to select your desired value.

<i>off</i>	OFF	Press the PTT switch and release it to end the transmission.
<i>on</i>	ON	When you press the PTT switch once, the pressed state will continue.
<i>2PPS</i>	2-times	When you press the PTT switch twice quickly, the pressed state will continue.

- 4 Press the **Menu** button to confirm the selection, then press the **PTT** switch or the **Side** button to return to the operation mode.

MODE RESET TIMER

This function returns the transceiver to the channel display after a preset timer expires while in channel menu mode or selcall mode.

To set the mode reset timer:

- 1 Enter the Setting mode {p.37}.
- 2 Press the ▲ or ▼ button to select “PSt tm”.



- 3 Press the **Menu** button then press the ▲ or ▼ button to select your desired value.

off	OFF	The channel menu mode and the selcall mode do not end automatically.
1~300	1(second) ~ 300(second)	After the set time has passed, exit channel menu mode or selcall mode. It can be set in steps of 1 second.

- 4 Press the **Menu** button to confirm the selection, then press the **PTT** switch or the **Side** button to return to the operation mode.

TIME-OUT TIMER

The Time-out Timer prevents you from using a channel for an extended duration. This function is useful, for example, when you accidentally keep the **PTT** switch pressed. Additionally, by limiting the amount of time you can continuously transmit, this feature helps you save on battery power consumption.

If you continuously transmit for 1 minute (default value), the transceiver will stop transmitting and a tone will sound. To stop the tone, release the **PTT** switch. You can press the **PTT** switch again to resume transmitting.

To change the default value of 1 minutes:

- 1 Enter the Setting mode {p.37}.
- 2 Press the ▲ or ▼ button to select “tot”.



- 3 Press the **Menu** button then press the ▲ or ▼ button to select your desired value.

15~600	15 (second) ~ 600 (second)	Set the time that you can extended durations to talk. It can be set in steps of 15 second.
--------	----------------------------	---

- 4 Press the **Menu** button to confirm the selection, then press the **PTT** switch or the **Side** button to return to the operation mode.

BUSY CHANNEL LOCKOUT

This function is used in order to prevent transmitting on a channel that somebody else is currently using. When turned ON, a beep sounds when you press the **PTT** switch while another party is using the channel, and you cannot transmit.

To turn Busy Channel Lockout on or off:

- 1 Enter the Setting mode {p.37}.
- 2 Press the ▲ or ▼ button to select “bcl”.



- 3 Press the **Menu** button then press the ▲ or ▼ button to select your desired value.

off	OFF	The Busy channel lockout function is deactivate.
on	ON	The Busy channel lockout function is activate.

- 4 Press the **Menu** button to confirm the selection, then press the **PTT** switch or the **Side** button to return to the operation mode.

INCORRECT SIGNALING NOTIFICATION

When signaling such as QT / DQT or RAN is set, it informs the signaling mismatch state by beep sound and LED.

- 1 Enter the Setting mode {p.37}.
- 2 Press the ▲ or ▼ button to select “d sig”.



- 3 Press the **Menu** button then press the ▲ or ▼ button to select your desired value.

off	OFF	Not notification even if signaling does not match.
on	ON	A beep sounds when signaling is does not match for more than 1 second. When signaling does not match, the LED blinking purple.

- 4 Press the **Menu** button to confirm the selection, then press the **PTT** switch or the **Side** button to return to the operation mode.

DISPLAY BACKLIGHT

You can set the display backlight to remain off, remain on, or turn on when you press any button other than the **PTT** switch (auto). When set to “Any”, the backlight remains on for 5 seconds after pressing a button, before turning off again.

To select the backlight setting:

- 1 Enter the Setting mode {p.37}.
- 2 Press the ▲ or ▼ button to select “LIGHT”.



- 3 Press the **Menu** button then press the ▲ or ▼ button to select your desired value.

off	OFF	The backlight does not light up.
RLT	Active	The Button operation lights the backlight. <ul style="list-style-type: none">• It does not light with the following button operation: PTT switch / Calling Alert / CW Message / Monitor / Monitor Momentary / Squelch Off / Squelch Off Momentary
Any	Any	When the speaker is muted, when the signal is received, the backlight will light.
on	ON	The backlight always lights up.

- 4 Press the **Menu** button to confirm the selection, then press the **PTT** switch or the **Side** button to return to the operation mode.

BATTERY SAVER

This transceiver has been designed to give you the most out of your battery power. The battery saver function decreases the amount of power used when a signal is not being received and no operations are being performed. While using the transceiver, battery saver will automatically switch ON after 5 seconds have elapsed with no operations or received calls. Operating the transceiver or receiving a call will switch this feature OFF until 5 seconds of non-operation occurs again.

To turn this function on or off:

- 1 Enter the Setting mode {p.37}.
- 2 Press the ▲ or ▼ button to select “b SAVE”.



- 3 Press the **Menu** button then press the ▲ or ▼ button to select your desired value.

oFF	OFF	The Battery Saver function is deactivate.
5	Short	The Battery Saver function activated and checks the presence or absence of the signal at 200 ms intervals.
m	Medium	The Battery Saver function activated and checks the presence or absence of the signal at 400 ms intervals.
L	Long	The Battery Saver function activated and checks the presence or absence of the signal at 800 ms intervals.

- 4 Press the **Menu** button to confirm the selection, then press the **PTT** switch or the **Side** button to return to the operation mode.

Note:

- ◆ While the Battery Saver is operating, the beginning of the received voice may be cut off.
 - ◆ While the Battery Saver is operating, operation of the button stops the of the battery saver.
-

BEEP TONE

When you press a button, a beep will emit from the transceiver.
To turn the beep tone on or off:

- 1 Enter the Setting mode {p.37}.
- 2 Press the ▲ or ▼ button to select “bEEP”.



- 3 Press the **Menu** button then press the ▲ or ▼ button to select your desired value.

<i>off</i>	OFF	No beep sounds.
<i>1~31</i>	1 ~ 31	Increasing the value increases the volume.
<i>Vol</i>	Volume	Adjust the volume with Power switch / Volume control. It becomes large in the clockwise direction and decreases in the counterclockwise direction.

- 4 Press the **Menu** button to confirm the selection, then press the **PTT** switch or the **Side** button to return to the operation mode.

SQUELCH LEVEL

You can adjust the default squelch level of the transceiver.

- 1 Enter the Setting mode {p.37}.
- 2 Press the ▲ or ▼ button to select “59L”.



- 3 Press the **Menu** button then press the ▲ or ▼ button to select your desired value.

<i>0~3</i>	0 ~ 3	If you want to receive weak carriers, decrease Squelch Level, and if unnecessary carriers exist, increase Squelch Level.
------------	-------	--

Note:

- ◆ In digital operation, Squelch Level is fixed at level 1.

- 4 Press the **Menu** button to confirm the selection, then press the **PTT** switch or the **Side** button to return to the operation mode.

MICROPHONE SENSE

You can adjust the sensitivity level of the transceiver microphone. It can be changed every in 2 dB steps.

To select the Microphone Sense:

- 1 Enter the Setting mode {p.37}.
- 2 Press the ▲ or ▼ button to select “m I L”.



- 3 Press the **Menu** button then press the ▲ or ▼ button to select your desired value.

L -20db n 0db H 6db	-20dB(low sensitivity) ~ 0dB(normal) ~ 6dB(high sensitivity)	The sensitivity decreases as the number of "-" increases. 0 dB is the standard sensitivity. The sensitivity increases as the number increases.
---------------------------	--	--

- 4 Press the **Menu** button to confirm the selection, then press the **PTT** switch or the **Side** button to return to the operation mode.

EXTERNAL MICROPHONE SENSE

You can adjust the sensitivity level of the external microphone. It can be changed every in 2 dB steps.

To select the External Microphone Sense:

- 1 Enter the Setting mode {p.37}.
- 2 Press the ▲ or ▼ button to select “E m I L”.



- 3 Press the **Menu** button then press the ▲ or ▼ button to select your desired value.

L -20db n 0db H 6db	-20dB(low sensitivity) ~ 0dB(normal) ~ 6dB(high sensitivity)	The sensitivity decreases as the number of "-" increases. 0 dB is the standard sensitivity. The sensitivity increases as the number increases.
---------------------------	--	--

- 4 Press the **Menu** button to confirm the selection, then press the **PTT** switch or the **Side** button to return to the operation mode.

MICROPHONE TYPE

Optional external microphones connected to the transceiver have different audio characteristics. By using this function, you can make the audio characteristics uniform and set for optimum conditions for Digital processing.

- 1 Enter the Setting mode {p.37}.
- 2 Press the ▲ or ▼ button to select “*m TYPE*”.



- 3 Press the **Menu** button then press the ▲ or ▼ button to select your desired value.

<i>oFF</i>	OFF	It does not correct audio characteristics.
<i>1</i>	1	Set for EMC-13 connection.
<i>2</i>	2	Set for EMC-14 connection.
<i>3</i>	3	Reserve
<i>4</i>	4	Set for KMC-55 connection.
<i>5</i>	5	Set for KHS-37 connection.
<i>6</i>	6	Reserve

- 4 Press the **Menu** button to confirm the selection, then press the **PTT** switch or the **Side** button to return to the operation mode.

AUDIO EQUALIZER (RX AUDIO RESPONSE)

This setting item is function for Digital communications. Received sound quality will change depending on the characteristics of the other side's use environment, voice quality, microphone, external connection equipment and so on. By using this function, you can adjust the received sound quality according to usage and preferences.

- 1 Enter the Setting mode {p.37}.
- 2 Press the ▲ or ▼ button to select “EQ P”.



- 3 Press the **Menu** button then press the ▲ or ▼ button to select your desired value.

Low	Low Boost	It suppresses the high range of voice, enriching the low range. It will be calm and natural sound quality.
FLAt	Flat	It becomes standard sound quality.
HIGH	High Boost	It emphasize the high range of the voice. It is a clear quality sound quality that emphasizes listening to conversation reliably.

- 4 Press the **Menu** button to confirm the selection, then press the **PTT** switch or the **Side** button to return to the operation mode.

AUDIO EQUALIZER (TX AUDIO RESPONSE)

This setting item is function for Digital communications. Transmission sound quality changes due to the characteristics of the environment using the transceiver, voice quality, microphone and external connection equipment. By using this function, you can adjust the transmission quality according to usage and preferences.

- 1 Enter the Setting mode {p.37}.
- 2 Press the ▲ or ▼ button to select “EQ t”.



- 3 Press the **Menu** button then press the ▲ or ▼ button to select your desired value.

Low	Low Boost	It suppresses the high range of voice, enriching the low range. It will be calm and natural sound quality.
FLAt	Flat	It becomes standard sound quality.
HIGH	High Boost	It emphasize the high range of the voice. It is a clear quality sound quality that emphasizes listening to conversation reliably.

- 4 Press the **Menu** button to confirm the selection, then press the **PTT** switch or the **Side** button to return to the operation mode.

ENCRYPTION KEY DATA

Set the encryption key to be used with the Encryption function.

Refer to operate private talk using Encryption key data. {p.17}

- 1 Enter the Setting mode {p.37}.
- 2 Press the ▲ or ▼ button to select "ENCKEY".



- 3 Press the **Menu** button then press the ▲ or ▼ button to select your desired value.

1 ~ 32767	1 ~ 32767	Select the your desired code from 1 to 32767.
-----------	-----------	---

- 4 Press the **Menu** button to confirm the selection, then press the **PTT** switch or the **Side** button to return to the operation mode.

VOX SETUP

Note:

- ◆ To use the VOX function, you need to set the VOX function to "ON" in channel set mode {p.33}.

VOX GAIN LEVEL

With VOX activated, your voice level will determine when you transmit. Due to the automatic switching between transmission and reception, we recommend you set the VOX gain level such that it will not activate when in an area with excessive ambient noise.

- 1 Enter the Setting mode {p.37}.
- 2 Press the ▲ or ▼ button to select "VOX Gain".



- 3 Press the **Menu** button then press the ▲ or ▼ button to select your desired value.

1 ~ 10	1 ~ 10	Adjust so that the VOX function works reliably when talking into the microphone. If it does not work even when you speak, gradually increase the level.
--------	--------	--

- While adjusting the VOX Gain level, speak into the microphone. When an appropriate level is reached, the LED lights yellow, but no signal is transmitted at this time.
 - Setting the VOX gain level to OFF deactivates VOX. In order to transmit with VOX turned off, you must use the **PTT** switch.
- 4 Press the **Menu** button to confirm the selection, then press the **PTT** switch or the **Side** button to return to the operation mode.

VOX DELAY TIME

If the transceiver returns to receive mode too quickly after you stop speaking, the end of your message may not be transmitted. To avoid this, select an appropriate delay time that allows your entire message to be transmitted. However, do not make the delay overly long.

- 1 Enter the Setting mode {p.37}.
- 2 Press the ▲ or ▼ button to select “*uDELAY*”.



- 3 Press the **Menu** button then press the ▲ or ▼ button to select your desired value.

<i>01/ 03/ 05</i> <i>/ 10/ 15/ 30</i>	0.1/ 0.3/ 0.5/ 1.0/ 1.5/ 3.0	During transmission, from 0.1 seconds to 3.0 seconds VOX transmission will continue if there is voice input reaching microphone sensitivity that operates VOX during the selected time.
--	------------------------------------	---

- 4 Press the **Menu** button to confirm the selection, then press the **PTT** switch or the **Side** button to return to the operation mode.

TRANSMIT INHIBIT WHILE RECEIVING

While using VOX, you can set the transceiver to detect when the channel is in use (in place of using the Monitor function). With this function turned on, VOX will not allow you to transmit while the channel is being used. You can transmit only when the channel is free.

- 1 Enter the Setting mode {p.37}.
- 2 Press the ▲ or ▼ button to select “*uT I*”.



- 3 Press the **Menu** button then press the ▲ or ▼ button to select your desired value.

<i>off</i>	OFF	Even if the channel is used, VOX will allow transmission.
<i>on</i>	ON	While the channel is being used, VOX will not allow you to transmit.

- 4 Press the **Menu** button to confirm the selection, then press the **PTT** switch or the **Side** button to return to the operation mode.

VOX PROCEED TONE

You can set the transceiver to sound an alert tone when you are able to transmit. This tone is used to prevent missing the beginning of the audio to be transmitted.

- 1 Enter the Setting mode {p.37}.
- 2 Press the ▲ or ▼ button to select “*uPpPα*”.



- 3 Press the **Menu** button then press the ▲ or ▼ button to select your desired value.

<i>off</i>	OFF	VOX proceed tone is not output.
<i>on</i>	ON	VOX proceed tone is output.

- 4 Press the **Menu** button to confirm the selection, then press the **PTT** switch or the **Side** button to return to the operation mode.

EARPHONE MODE

Normally, when the monaural earphone is connected, the **PTT** switch of the transceiver can not be used, If you set the earphone mode to ON, you can transmit using the **PTT** switch of the transceiver.

Note:

- ◆ Please use KENWOOD recommended product for monaural earphones.

- 1 Enter the Setting mode {p.37}.
- 2 Press the ▲ or ▼ button to select “*EARPHo*”.



- 3 Press the **Menu** button then press the ▲ or ▼ button to select your desired value.

<i>off</i>	OFF	When using a dedicated optional earphone microphone, headset, speaker microphone.
<i>on</i>	ON	When using the recommended monaural earphone.

- The  icon appears on the display when “ON” is selected.

- 4 Press the **Menu** button to confirm the selection, then press the **PTT** switch or the **Side** button to return to the operation mode.

Operation of each part by Earphone mode

	Connection with SP/MIC jack	YES		NO	
	Earphone mode	OFF	ON	OFF	ON
Internal	Microphone	disable	enable	enable	enable
	Speaker	disable	disable	enable	enable
	PTT	enable	enable	enable	enable
External	Microphone	enable	disable		
	Speaker	enable	enable		
	PTT	enable	disable		

SELECTABLE POWER ON LED

Setting the color of the LED that lights up when the power is on, groups can be color coded when grouping is necessary. Once you have decided on the color of group, you can judgment which group immediately after turning on the power. You can set the colors of the LED that light up at power on from 7 types.

It will light for about 2 seconds.

To set the power on color type of LED:

- 1 Enter the Setting mode {p.37}.
- 2 Press the ▲ or ▼ button to select "PonLEd".



- 3 Press the **Menu** button then press the ▲ or ▼ button to select your desired value.

oFF	OFF	Even if the power is turned on, the LED does not light up.
YEL	Yellow	When the power is on, the LED will light yellow for about 2 seconds.
PPL	Purple	When the power is on, the LED will light purple for about 2 seconds.
BLU	Blue	When the power is on, the LED will light blue for about 2 seconds.
L BLU	Light Blue	When the power is on, the LED will light light blue for about 2 seconds..
REd	Red	When the power is on, the LED will light red for about 2 seconds.
GRn	Green	When the power is on, the LED will light green for about 2 seconds.
wHt	White	When the power is on, the LED will light white for about 2 seconds.

- 4 Press the **Menu** button to confirm the selection, then press the **PTT** switch or the **Side** button to return to the operation mode.

SELECTABLE POWER ON TONE

You can set up a tone to sound during power on to one of 4 types.
To set the power on tone type:

- 1 Enter the Setting mode {p.37}.
- 2 Press the ▲ or ▼ button to select "Pon to".



- 3 Press the **Menu** button then press the ▲ or ▼ button to select your desired value.

1 ~ 4	1 ~ 4	Select from 4 type tones.
-------	-------	---------------------------

- 4 Press the **Menu** button to confirm the selection, then press the **PTT** switch or the **Side** button to return to the operation mode.

BACKGROUND OPERATIONS

BATTERY LEVEL INDICATOR

When turned ON, the battery level indicator on the display lets you know approximately how much battery life is remaining. When turned OFF, the battery level indicator will not be displayed.

When the battery voltage becomes too low while transmitting, the transceiver stops transmitting, a tone sounds, and the LED blinks red until you release the **PTT** switch. Recharge or replace the battery pack at this time.



High battery power



Medium battery power



Low battery power



Recharge the battery pack

RESETTING THE TRANSCEIVER

At some point in time, you may desire to reset the transceiver settings to their default values. (The default values are listed in the "Channel menu mode" and "Setting mode" tables.)

To reset the transceiver:

- 1 With the transceiver power OFF, press and hold the ▲ and ▼ buttons while turning the transceiver power ON.
 - "RESET" (reset) will appear on the display.
- 2 Release the ▲, or ▼ buttons.
 - The confirmation message "SURE" (sure) will appear on the display.
- 3 Press the **PTT** switch to reset the transceiver.
 - Press any other button to cancel the reset.

RESET

SURE

Note:

- ◆ Reset will function even if Super Lock has been activated.
-

OPTIONS

The following options are available for use with this transceiver.

Model Name	Name
KSC-50CR	Charger Pocket
KNB-81L	Battery pack
KSC-506	Multiple Charger (6 units)
KBH-22	Belt Clip Holster
KPG-D5	Programming software
KSC-44SL	AC Adapter (Single)
KSC-44ML	AC Adapter (Multiple)
KBH-14	Belt Clip
KBH-20	Belt Clip
KBH-21	Belt Clip
KMC-55	Speaker Microphone
EMC-13	Clip Microphone with Earphone
EMC-14	Clip Microphone with Earphone
KHS-37	Headset
KHS-10-OH-SD	Headset
KHS-22-OH-SD	Headset
KHS-7A-SD	Headset
KPG-186U	Programming Cable

Note:

- ◆ Optional accessories for use with this transceiver may change, post-production. (New options may become available and/or current options may be discontinued.) Please refer to the options catalog(s) for applicable transceivers.

TROUBLESHOOTING GUIDE

Problem	Solution
Cannot turn the transceiver power ON.	<ul style="list-style-type: none"> The battery pack may be dead. Recharge or replace the battery pack. The battery pack may not be installed correctly. Remove the battery pack and install it again.
Battery power dies shortly after charging.	<ul style="list-style-type: none"> The battery pack life is finished. Replace the battery pack with a new one.
Cannot talk to or hear other members in your group.	<ul style="list-style-type: none"> Make sure you are using the same frequency and QT/DQT or RAN setting as the other group members. Other group members may be using Privacy Talk. Turn on your transceiver's Privacy Talk. Other group members may be too far away. Make sure you are within range of the other transceivers.
Other voices (besides group members) are present on the channel.	<ul style="list-style-type: none"> Change the QT/DQT or RAN settings. Make sure all group members change the settings on their transceivers to match the new QT/DQT or RAN setting.
You cannot make a selcall.	<ul style="list-style-type: none"> Verify and set your transceiver ID (Own, Group, All).
You cannot receive calls except selcalls. You cannot transmit even by pressing the PTT switch.	<ul style="list-style-type: none"> Optional Signaling is set to "FS (FleetSync)". Change the setting to "oFF (OFF)".
The transceiver is malfunctioning for no apparent reason.	<ul style="list-style-type: none"> Reset the transceiver as described on {p.65}.

SPECIFICATIONS

RF output power	High	2.0 W
	Low	1.0 W
Audio output power	Max 750 mW or more	
Frequency stability	±2.5 ppm	
Operating voltage	DC 3.8± 0.4 V	
Dimensions (W x D x H) (projections not included)	50 × 94 × 27 mm (1.97 x 3.70 x 1.06 in)	
Weight (with KNB-81L)	160 g (5.6 oz)	

KENWOOD

© 2018 JVCKENWOOD Corporation